

EZ Series EH

Vertical Water Source Heat Pump Replaces Singer/McQuay HC/EH and ElectroHydronic Units

Islandaire "The Perfect Fit" units are designed to exactly replace the original, existing chassis! No field modification kits or builder renovations are required. Islandaire units are designed for optimal efficiency and reliability. This unit has the same connection locations, and by using the existing blower section and existing cabinet, time and money is saved!

This appliance is intended for new construction or replacement of Singer, McQuay and ElectroHydronic EH water source heat pumps. Please confirm that the electrical rating of this appliance matches the electrical supply available before beginning installation.

Features on the EZ Series EH:

- Proudly made in the U.S.A
- Superior energy efficient ratios (EER)
- High efficiency coaxial condenser coil
- High efficiency evaporator coil
- Commercial duty construction with heavy gauge galvanized steel
- High pressure protection
- Compressor and water circuit freeze protection
- Refrigerant circuit access ports
- Blower assembly, control module or remote available
- Power Disconnect Switch

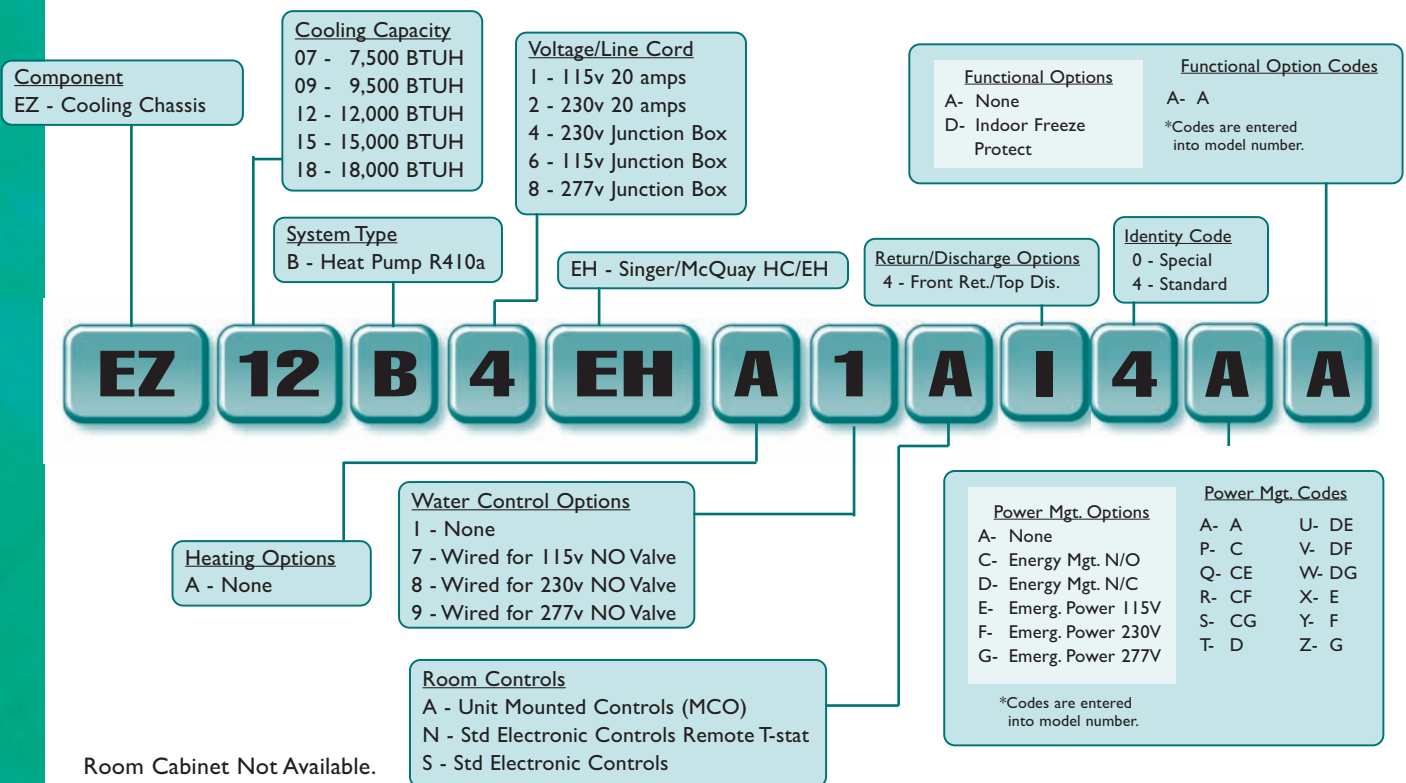
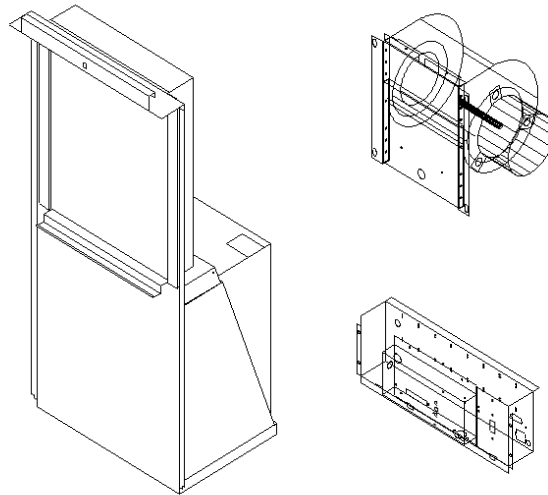

EZ Series EH







ENVIRONMENTALLY SOUND REFRIGERANT 

Slide the old EH unit out, slide "The Perfect Fit" Islandaire unit in! No Renovations!

MODELS																			
	EZ07				EZ09				EZ12				EZ15			EZ18			
VOLTS	115	230	208	277	115	230	208	277	115	230	208	277	230	208	277	230	208	277	
BTUH COOLING	8,100	8,100	7,900	8,100	9,300	9,300	9,100	9,300	12,200	12,200	12,000	12,200	15,000	14,800	15,000	19,000	18,800	19,000	
AMPS	6.3	3.4	3.5	3.2	8.8	4.4	4.5	3.8	10.3	6.2	6.5	5.0	6.7	7.1	5.9	8.1	8.3	7.2	
WATTS COOLING	575	575	535	575	691	691	661	691	897	897	867	897	1119	1100	1119	1426	1406	1426	
EER	14.0	14.0	14.0	14.0	13.5	13.5	13.5	13.5	13.6	13.6	13.6	13.6	13.4	13.4	13.4	13.3	13.3	13.3	
CFM HIGH	420	420	410	420	420	420	410	420	460	460	450	460	460	450	460	545	535	545	
CFM LOW	280	280	270	280	280	280	270	280	320	320	310	320	380	370	380	400	390	400	
BTUH HEATING	9,600	9,600	9,580	9,600	12,000	12,000	11,800	12,000	15,000	15,000	14,800	15,000	17,900	17,870	17,900	22,100	22,068	22,100	
WATTS HEATING	610	610	600	610	771	771	751	771	953	953	933	953	1370	1350	1370	1476	1446	1476	
C.O.P.	4.6	4.6	4.6	4.6	4.5	4.5	4.5	4.5	4.6	4.6	4.6	4.6	4.6	4.6	4.6	4.5	4.5	4.5	
G.P.M.	2.0	2.0	2.0	2.0	2.0	2.0	2.0	2.0	3.0	3.0	3.0	3.0	3.8	3.8	3.8	4.6	4.6	4.6	

Note: Data based on ARI Standard 320
 Cooling - Entering Air - 80 deg. F DB \67 DEG. F WB
 - Entering Water - 85 deg. F
 Heating - Entering Air - 70 deg. F DB
 - Entering Water - 70 deg. F

Line Voltage	Maximum Amperage	Wall Socket Configuration	Receptacle Number
115	16		NEMA 5-20R
208/230	16		NEMA 6-20R
208/230	24		NEMA 6-30R
277	16		NEMA 7-20R
208/230	12		NEMA 6-15R

